

Thank you very much for purchasing Cleansui. Read these instructions carefully before use. A warranty card is included with this product, and this must be stored for future reference.

## Instruction Manual Contents

- |   |                              |
|---|------------------------------|
| 1. Checking All Accessories                     | 8. Installations             |
| 2. Safety Precautions                           | 9. 3-way Diverter lever      |
| 3. Precautions During Use                       | 10. Replacement of Cartridge |
| 4. Faucets to which Cleansui cannot be attached | 11. Maintenance              |
| 5. Names of Parts                               | 12. Troubleshooting          |
| 6. Attaching/Replacing Cartridge                | 13. Specifications           |
| 7. Selecting the Attachment Accessory           | 14. After-Sale Service       |

### 1. Checking All Accessories

Check to ascertain that all of the following items are included in the package when it is first opened.

CB013E

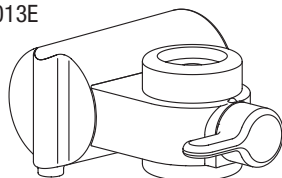

- ① Main unit (Complete with 1 cartridge)
- ② Attachment set
- ③ Instruction manual
- ④ Cartridge replacement reminder sticker

CB073E

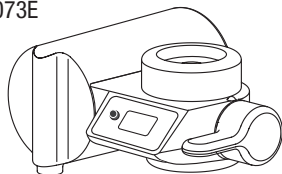

- Attachment Set



Contact your dealer immediately in the event of missing accessories or damage.

## 2. Safety Precautions

For your safety, please read the precautions carefully before installation or usage. Disregard or improper installation/usage may cause damages or results in dire consequences.

● The following warning symbols are used in this manual.



**Warning**

Never ignore this instruction. Failure to observe may result in injury or damage to surrounding assets.



**Forbidden**

Indicates the actions that are prohibited for safety precautions.



**No Dismantling**

Indicates that the product must not be dismantled under any circumstances.



**Instruction**

Indicates the instructions that must be observed.



**Warning**



**Instruction**

- Use tap water that meet the standard requirements for drinking water.



(Failure to observe this may result in illness.)





**Forbidden**

- Do not use with water that is microbiologically unsafe or unknown quality without adequate disinfection before or after the system.
- Contact the dealer in the event of the product being damaged. Do not touch the damaged area under any circumstances.

## Using Filtered water

 Instruction	<ul style="list-style-type: none"><li>● <b>Best to use/drink instant filtered water as soon as possible, fresh water is better than stale water kept for some time. If you like to store filtered water, we recommend storage in a closed lid container in a refrigerator.</b> (There is a risk-bacteria, other impurities from the air etc. may settled in stale water, as residual chlorine is removed)</li></ul>
 Forbidden	<ul style="list-style-type: none"><li>● <b>Do not use filtered water for breeding fishes, etc.</b></li></ul>



## Maintaining Hygiene

 Instruction	<ul style="list-style-type: none"><li>● <b>Run the filtered water for at least 10 seconds before using your Cleansui for the first time of usage every day.</b> (How to maintain best hygiene care to avoid spread of bacteria, etc.)</li><li>● <b>Run the filtered water for at least 1 minute to discharge accumulated water when Cleansui has not been used for 2 or more days.</b> (How to maintain best hygiene care to avoid spread of bacteria, etc.)</li></ul>
 Forbidden	<ul style="list-style-type: none"><li>● <b>Do not touch the filtered water outlet with hands.</b> (How to maintain best hygiene care to avoid spread of bacteria, etc.)</li></ul>

## The Risk of the Filtering Abnormalities, Water leakage and Damages

 Instruction	<ul style="list-style-type: none"><li>● <b>Always ensure that the main unit and cartridge are used in combination as a set.</b> (Failure to observe this may result in damage or water leakage.)</li></ul>
	<ul style="list-style-type: none"><li>● <b>Turn the tap (ON/OFF) very slowly.</b> (Failure to observe this may result in damage or water leakage.)</li></ul>
	<ul style="list-style-type: none"><li>● <b>Please replace the cartridge when the flow rate of filtered water drops.</b> (Failure to observe this may result in damage or water leakage.)</li></ul>
	<ul style="list-style-type: none"><li>● <b>Please reduce tap water flow speed especially in areas with very high water pressure.</b> (The cartridge purifying function may not be at optimum filtration performance if the waterpressure is too high.) (Failure to observe this may result in damage or water leakage.)</li></ul>

## The Risk of the Filtering Abnormalities, Water leakage and Damages

 <p>Instruction</p>	<ul style="list-style-type: none"><li>● <b>Do not allow Cleansui to freeze.</b> (Failure to observe this may result in damage or water leakage.)</li><li>● <b>Do not run water with a temperature of 35 degrees Celsius or higher through to the cartridge/filtered water mode.</b> (Failure to observe this may reduce the effectiveness of the activated carbon and result in absorbed properties (odors, etc.) which may affect the filtered water.)</li><li>● <b>Do not run water with a temperature of 60 degrees Celsius or higher through to the straight tap water or spray tap water mode.</b> (Failure to observe this may result in damage or water leakage.)</li><li>● <b>Do not obstruct the filtered water outlet or attach other equipment to it.</b> (Failure to observe this may result in damage or water leakage.)</li><li>● <b>Do not use detergent or alcohol, etc., to clean the product.</b> (Failure to observe this may result in cracking, scratching, discoloring or malformation. See [11. Maintenance] for further details.)</li><li>● <b>Do not submerge Cleansui in water during maintenance.</b> (Failure to observe this may result in damage.)</li></ul>
 <p>Forbidden</p>	<ul style="list-style-type: none"><li>● <b>Do not connect flash stopcock-type water heaters or stopcock-type electric water heaters.</b> (Failure to observe this may result in damage or water leakage.)</li><li>● <b>Do not install in locations that are close to naked flames or high temperatures.</b> (Failure to observe this may result in damage or water leakage.)</li></ul>
 <p>No Dismantling</p>	<ul style="list-style-type: none"><li>● <b>Do not dismantle the unit or the cartridge.</b><ul style="list-style-type: none"><li>• See [12. Troubleshooting] if you think something is wrong.</li></ul></li></ul>

### 3. Precautions During Use

- **There are incompatible faucets to which Cleansui cannot be attached.**
  - See [4. Faucets to which Cleansui cannot be attached] for further details.
- **Precautions when attaching Cleansui to mixed-water faucets.**
  - There are rare incidents when the gas flames on the water heater will not ignite properly.
  - There are incidents when the safety valve on the water heater operates if it is not equipped with a non-return valve.
  - There are incidents when the temperature of the shower water is not stable in locations with low water pressure and when storage heaters are in use.
- **The lifespan/replacement period of a cartridge will differ in accordance to the volume of filtered water, tap water quality, water pressure etc.**
  - See [10. Replacement of Cartridge] for further details.
- **It is not advisable use hot-spring water, well water or any other water that contains large amounts of impurities.**
- **The working pressure for using Cleansui is between 0.07 and 0.35MPa.**
- **When the unit has not been used for a long period of time or the tap water has a red tinge (turbidity,) allow tap water to flow through straight or spray tap water mode for some time before switching to instant filtered water mode.**
- **This model cannot remove saline (seawater) or metallic ions present in water, although it can remove heavy metal particles/turbidity. It is also not capable of converting hard water to soft water.**
- **Use the filtered water for drinking, cooking and washing of vegetables/fruits.**
  - The lifespan of the cartridge will be greatly reduced if it is used for washing dishes, etc.

### 4. Faucets to which Cleansui cannot be attached

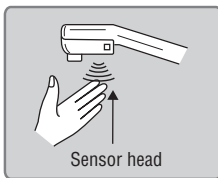
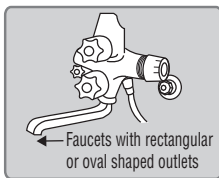
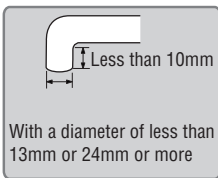

Optional special attachment accessories (sold separately on request) may fit faucet less than 10 mm when accessories supplied do not fit.  
Contact your dealer.

## 5. Names of Parts

### ● Cross-section of Unit

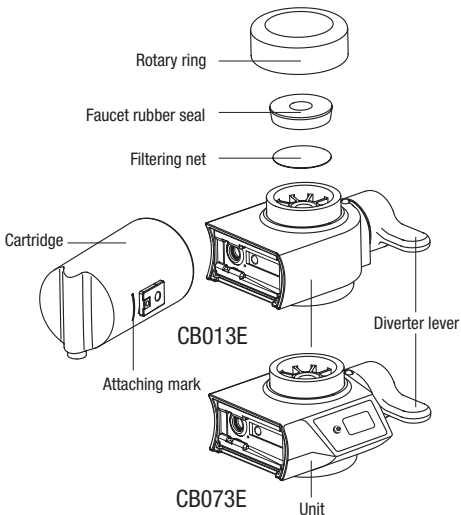

### ● Rear View

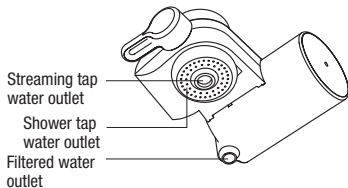

## The case of CB073E

The display counts down from time to replace the cartridge by pressing the reset button. The bar will disappear one by one about every half a month.

\* Regardless of the water flow rate, it displays the elapsed time.

At the first time to use the product and after replacing the cartridge, please press the reset button.

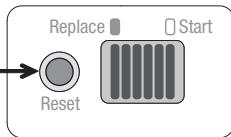

- At the first time to use the product: Press the reset button until the display lights up everything. (approx. 1 sec.)



-After the replacing the cartridge: Press the reset button until the display lights up one bar. (approx. 3 sec.)



Lifetime:  
approx. 3 months

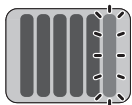

When reset

Lifetime:  
approx. 2 months

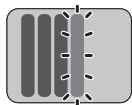

Lifetime:  
approx. 1 month

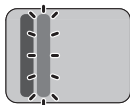

Time to replace  
the cartridge

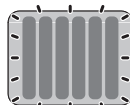

Lights up everything

## 6. Attaching / Replacing Cartridge

- Ensure water supply is completely turned off when removing or attaching cartridges.
- Write the date of cartridge on first day of usage (and at every cartridge replacement) on sticker provided, stick the sticker on the cartridge to provide a reminder for next replacement.
- Attach/replace new cartridge in a clean space to avoid any water splash or contamination.
  - Avoid water splash from used cartridge.
- Make sure there is sealing packing of connection fitted.



### Attaching cartridge

Align the attaching mark of cartridge with the front of body and slide it to back.



Until the sound the attaching is completed

Top view

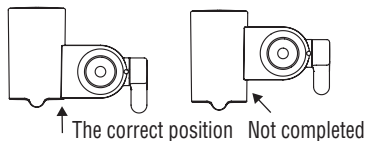

### Detaching cartridge

Slide the cartridge to front until the sound the detaching is completed.

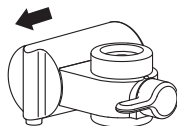

## 7. Selecting the Attachment Accessory

- Check your faucet type. Look closely at the edge/tip—that will tell you which attachment will be best fit. Use/fix the best fit attachment accessory.
  - Store unused attachment accessory as they may be useful in future if you change your faucet or move to a new home.
- There are faucets to which Cleansui cannot be attached.
  - Refer to [4. Faucets to which Cleansui cannot be attached] for further details.
- Check to ensure that there are no cracks or burrs on the edge of the faucet.
- Unstable and loose connections with the faucet may result in Cleansui leaking or being damaged.

## 8. Installations

### Straight edge faucets

CL  
540

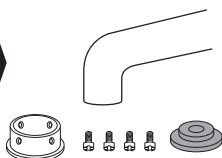

**1** Insert the rotary ring inside the screw-stopper ring

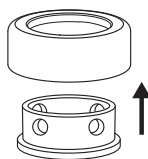

**2** Temporarily tighten the four screws

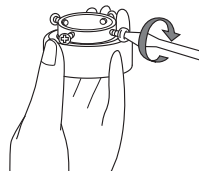

### Outer screw tip faucets

CL  
521

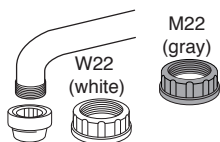

**1** Remove the metal loose tip on faucet in a clockwise direction. Remove any loose rubber washer that may still be inside the current faucet.

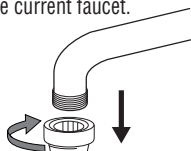

A wrench may be necessary if it is too tight.

**2** Insert the new rubber washer into the neck.

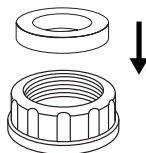

### Inner screw tip faucets

CL  
531

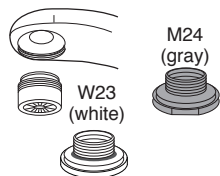

**1** Remove the metal loose tip on faucet in a clockwise direction. Remove any loose rubber washer that may still be inside the current faucet.

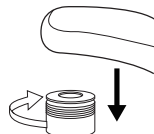

A wrench may be necessary if it is too tight.

**2** Insert the new rubber washer into the neck.

\* When the M24 is to be used.

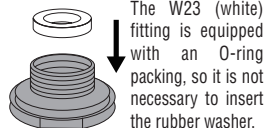

### Option

Faucets to which Cleansui can be affixed using optional attachment

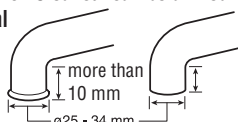

CS002C





- 3** Insert the rubber washer, turn the rotary ring once on the main unit's ring portion, tighten gently.

(Note that it will be impossible to tighten it correctly in Step #5 as excessive turning prevent tightening.)

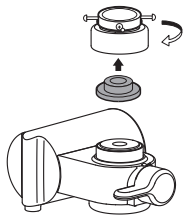

- 4** Firmly press the unit onto the bottom of the faucet and tighten the screws. Make sure that the faucet is located in the center of the screw stopper ring

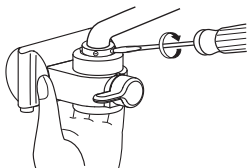

- 5** Tighten the rotary ring tightly to complete the procedure

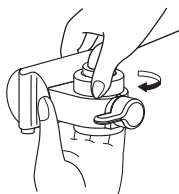

- 3** Slip the rotary ring into the faucet. In anti-clockwise direction, tighten the attachment with washer intact. Turn the rotary ring so that it is face upward, and then tighten/position to fit nicely onto main unit ring



- 4** Use a coin or something similar (slot into rear indent of accessory) and tighten gently.

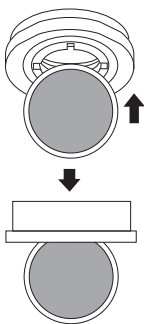

- 5** Set the main unit in place

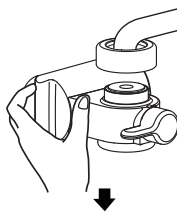

- 3** Slip the rotary ring into the faucet. In anti-clockwise direction, tighten the attachment with washer intact. Turn the rotary ring so that it is face upward, and then tighten/position to fit nicely onto main unit ring

\* Same for both W23 (white) and M24 (gray)

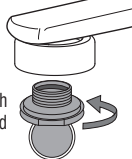

- Tighten the rotary ring gently but not very tightly to complete the procedure

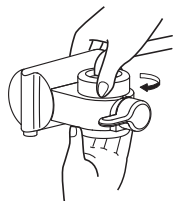

## 9. 3-way Diverter dial

Run water on and off from the faucet, use the lever on the unit to switch between tap water/straight, tap water/spray or filtered water. See the following illustrations for further details.

### ● Tap water (straight)

Set the lever to

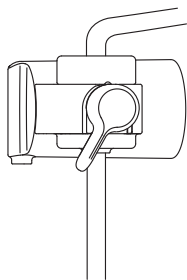

### ● Tap water (spray)

Set the lever to

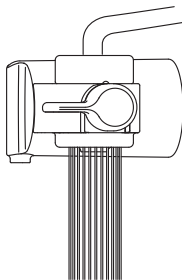

### ● Filtered water

Set the lever to

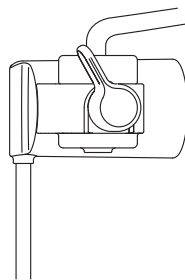

When you use the product for a first time and run the filtered water immediately after replacing the cartridge

- Shift the diverter lever to the position of spray mode, and turn the tap ON very slowly and then change the diverter lever to the position of filtered water mode.
- Check for leaks and other abnormal signs and then change the diverter lever to the position of filtered water mode.

(Unstable and loose connections with the faucet may result in the product leaking or being damaged.)

● Bubbles may be present in filtered water when used first time, this is not a defect. It denotes that presence of air in the cartridge.

- It means that air is contained within the main unit.

## 10. Replacement of Cartridge

Cleansui unique state-of-art filtration system remove unhealthy substances but leave healthy minerals intact to give you clean natural delicious water straight from your tap.

The lifespan of a cartridge may vary subject to the volume of water purified, source water quality, water pressure etc.

\* Recommendation: Please replace the cartridge when you notice the following.

### 1. When the odor of residual chlorine or other odors are obvious.

→ The performance of the activated carbon have deteriorated.

### 2. When the flow rate/volume of purified water is substantially lower than usual speed e.g. it takes 15 or more seconds to fill a cup.

→ The hollow fiber membrane filters are clogged. The flow rate will not increase even when the faucet is switch on maximum.

- There is a possibility that cracks have appeared (when it is badly clogged), so it is necessary to replace the cartridge.

Replacement Cartridge : CBC03E

## 11. Maintenance

### 1. Rinse Cleansui with water (no detergent, etc.) prior to usage.



Do not use detergent, cleaner, thinner, benzene, alcohol, oil or any other agent for cleaning Cleansui.

- Failure to observe this may result in cracks, scratches, discoloring or malformation.

**Forbidden** • Wipe immediately if any of these substances come into contact with the unit.

### 2. The rubber seal is expendable, replace when it is old or worn.

### 3. Rinse the shower head with water and a soft brush (do not use detergent, etc.) to clean it. Set the position of the 3 way diverter lever to tap water spray for a few moments after cleaning it.

## CB073E

LCD cleaning → Wipe the LCD with a clean cloth.

- Display has a life of approximately five years.
- At the end of its life, it needs to be disposed correctly. The battery is sealed within the unit, dispose the whole unit in accordance with local regulations for battery disposal. You will be able to order a new unit from the dealer.

## 12. Troubleshooting

Problem	Potential Causes	Recovery
Water leakage at attachment accessory	Had the accessories been attached to the faucet correctly?	Re-attach the unit from the beginning.
	Is the tip of the faucet damaged?	The faucet need to be repaired, or the heat-insulation packing needs to be replaced.
	Is the rubber seal damaged?	Replace the rubber seal.
Low water volume/slow flow from both the tap water and shower head	Is the filtering net stained?	Rinse the shower head with water and a sanitary toothbrush (do not use detergent, etc.) to clean it. Set the position of the 3 way diverter lever to tap water spray for a few moments after cleaning it.
Shower head output is not even	Is the shower head stained?	
Low filtered water volume	Could the hollow fiber membrane be clogged. Refer to [10. Replacement of Cartridge] for further details.	Replace the cartridge.
	The water pressure is low	This is not a defect
	The water temperature is low	This is not a defect
Strange taste or odor in filtered water	Is the cartridge lifespan up, is it due for replacement. Refer to [10. Replacement of Cartridge] for further details.	Replace the cartridge.
Bubbles in filtered water when used for the first time	This is not a defect.	This is not a defect. Air is present in the unit.

## 13. Specifications

Model number	CB013E		CB073E
		Cartridge: CBC03E	
Material	ABS		
Filter media	Polyethylene hollow fiber membrane, activated carbon		
Filtration flow rate	1.6litres/minute		
Minimum water pressure	0.07MPa		
Filtration Performance *Based on results of JIS S 3201	Free residual chlorine	900 litres	80% removed
	Turbidity	900 litres	50% filtration flow rate
	Trihalomethanes	900 litres	80% removed
	Chloroform	900 litres	80% removed
	Bromodichloromethane	900 litres	80% removed
	Dibromochloromethane	900 litres	80% removed
	Bromoform	900 litres	80% removed
Dimensions	131 (W) X 100 (D) X 59 (H) mm		
Weight ( when filled with water)	200g (300g)		220g (320g)

Removal performance \*Based on JWPAS B.100.

Iron (fine particle) 80% removed

Aluminum (neutral) 80% removed

\*These removal substances determined by Japan Water Purifier Association.

## 13. Specifications and Performance

NSF/ANSI Standard 42 – Aesthetic Effects			Model # CB013E, CB073E
Substance	Influent Challenge Concentration	Overall Percent Reduction	Reduction Requirement
Chlorine	2.0 mg/L + /-10 %	95.8 %	≥ 50 %
NSF/ANSI Standard 53 – Health Effects			Model # CB013E, CB073E
Substance	Influent Challenge Concentration	Overall Percent Reduction	Reduction Requirement
Cysts	minimum 50,000/L	> 99.99 %	99.95 %
Substance	Influent Challenge Concentration	Overall Percent Reduction	Maximum permissible product water concentration
Turbidity	11 ± 1 NTU	99.1 %	0.5 NTU

Maintenance according to the manufacturer's instructions is critical for proper filter performance. Filter life should not exceed 900 liters. If filtering time is notably increased, replace the filter earlier.

This system has been tested according to NSF/ANSI 42 and 53 standards by NSF International for reduction of the substances listed above. The concentration of the indicated substances in water entering the system was reduced to a concentration less than or equal to the permissible limit for water leaving the system, as specified in NSF/ANSI 42 and 53.

The system conforms to NSF/ANSI 42 and 53 for specific performance claims as verified and substantiated by test data. While testing was performed under standard laboratory conditions, actual performance may vary.

The use of this system shall comply with applicable state and local laws.

Water pressure (min/max): 70 kPa / 350 kPa. Capacity: 900 liters.

Service flow rate: 1.6 l/min.

Filtered water temperature (min/max): 1 °C /35 °C Electrical requirements: none.

Replacement Cartridge: CBC03E

## 14. After - Sale Service

### ● Warranty

Cleansui water purifier comes with a warranty. Full details including dealer's name, the date of purchase etc. must be completed accurately and duly return. The validity of the warranty is one years from the date of purchase, subject to terms & conditions listed on warranty.

### ● Requested Repairs

1. When repairs are required during the validity period of the warranty, take the product and the warranty card to your dealer.
2. Seek your dealer's advice if repairs are required after warranty lapse. There will be a chargeable repair service fee.
3. Parts for Cleansui water purifier (including the cartridge) will be kept in stock and made available for a minimum of five years after the product has been discontinued.